

O 1

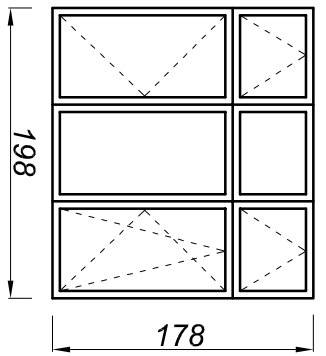

O 3

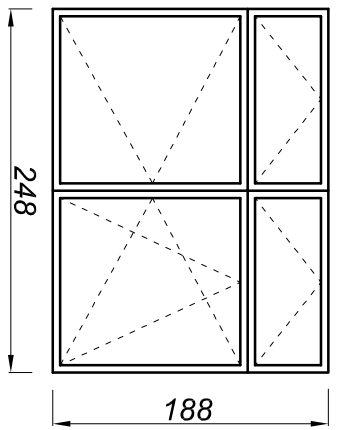

O 4

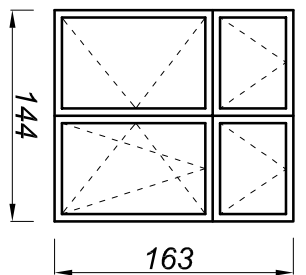

O 5

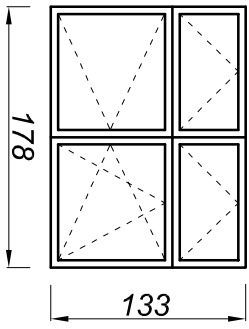

O 7

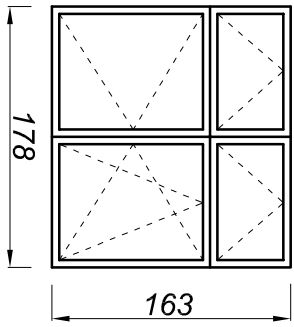

O 8

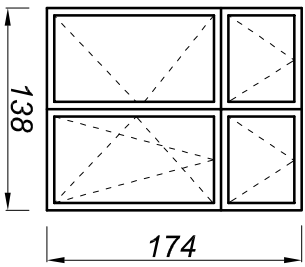

O 11

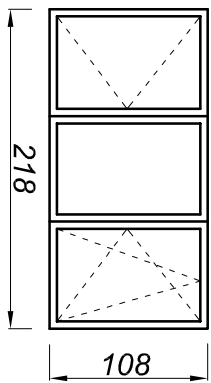

O 14

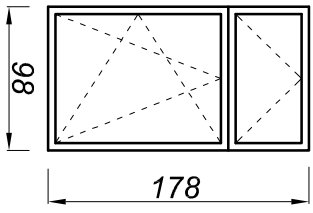

O 15

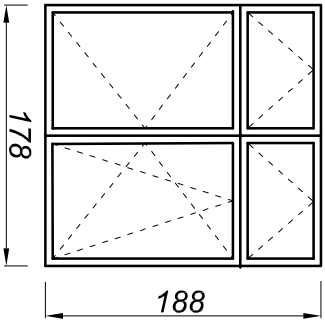

O 16

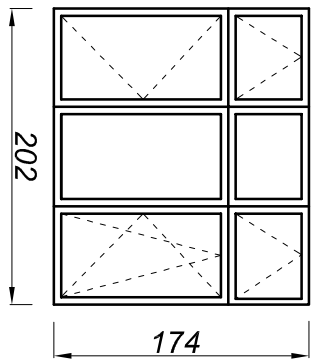

O 17

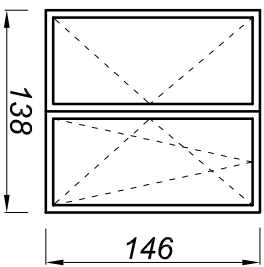

O 19

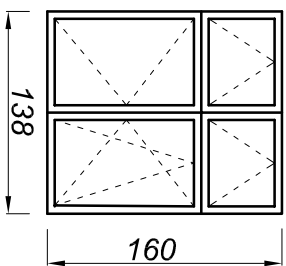

O 21

O 23

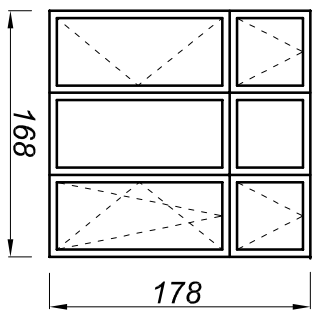

O 24

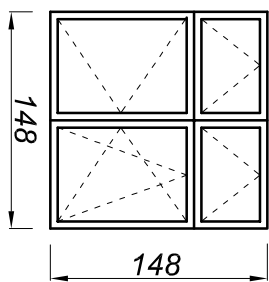

O 25

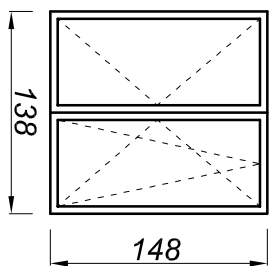

OS 1

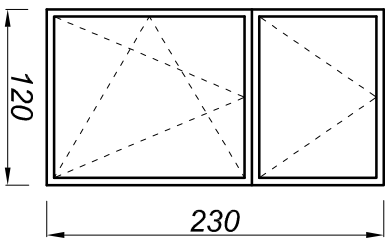

OS 2

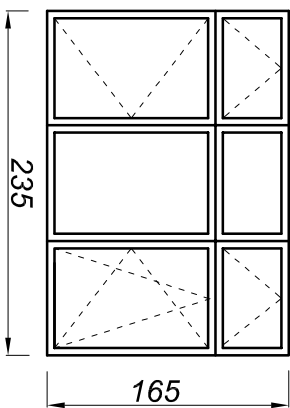

OS 3

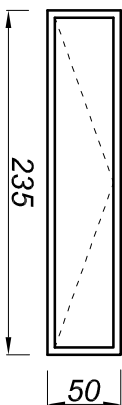

OS 4

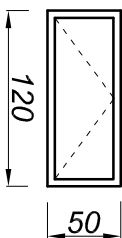

O 2

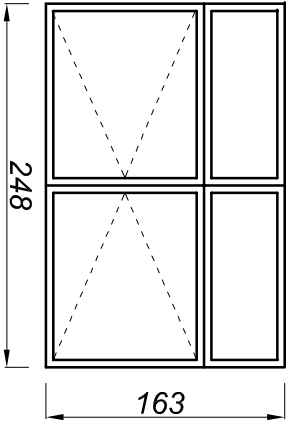

O 6

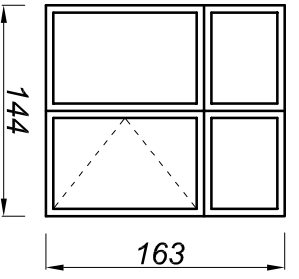

O 9

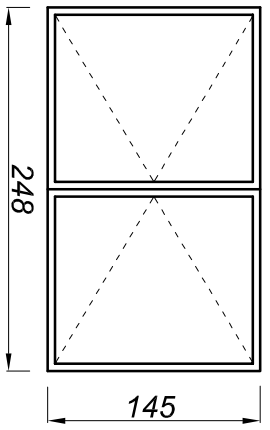

O 12

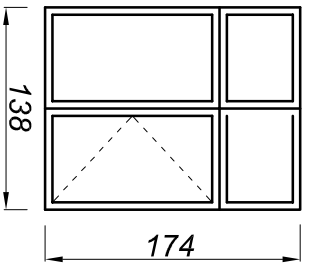

O 13

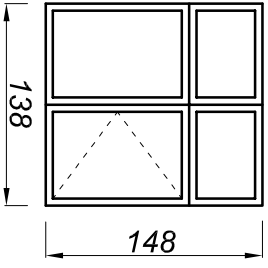

O 18

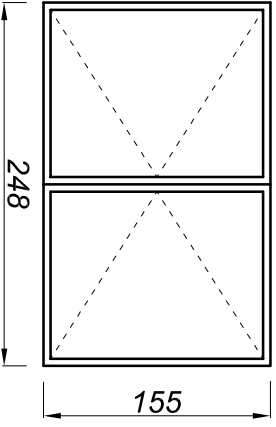

O 20

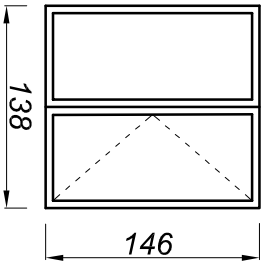

O 22

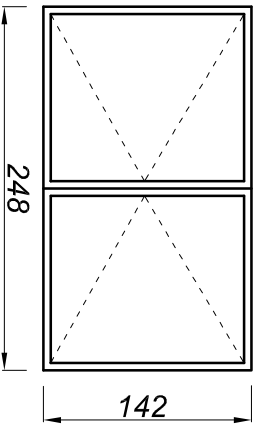

DZP

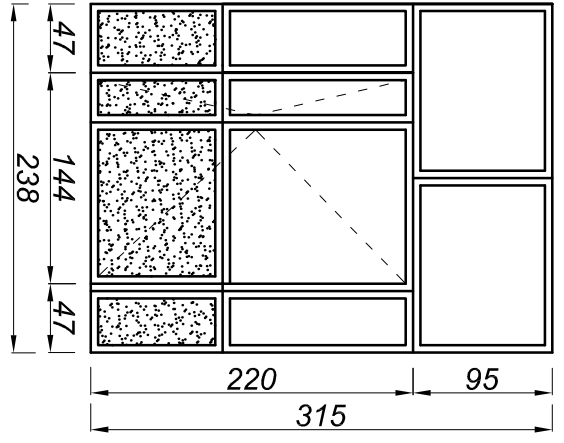

DWP

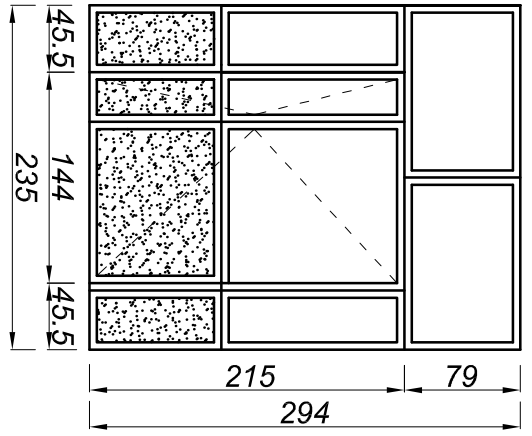

DZ 1

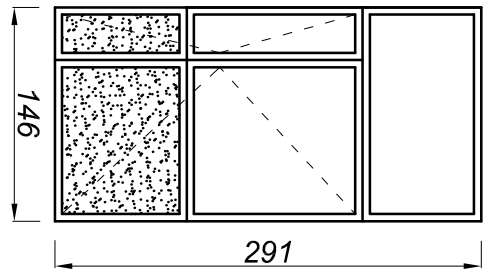

DZ 3

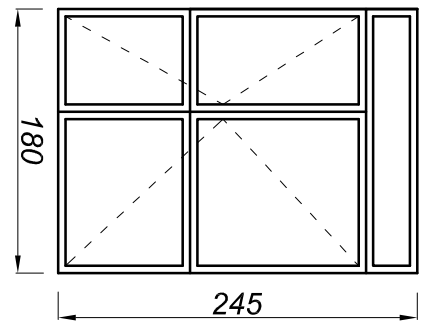

D 12

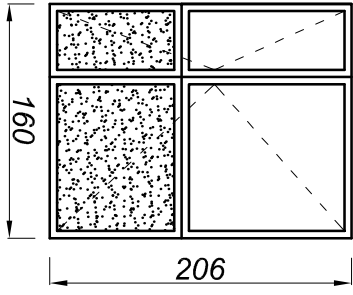

O 10

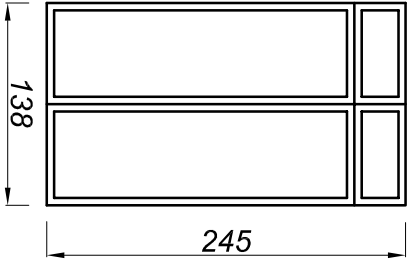

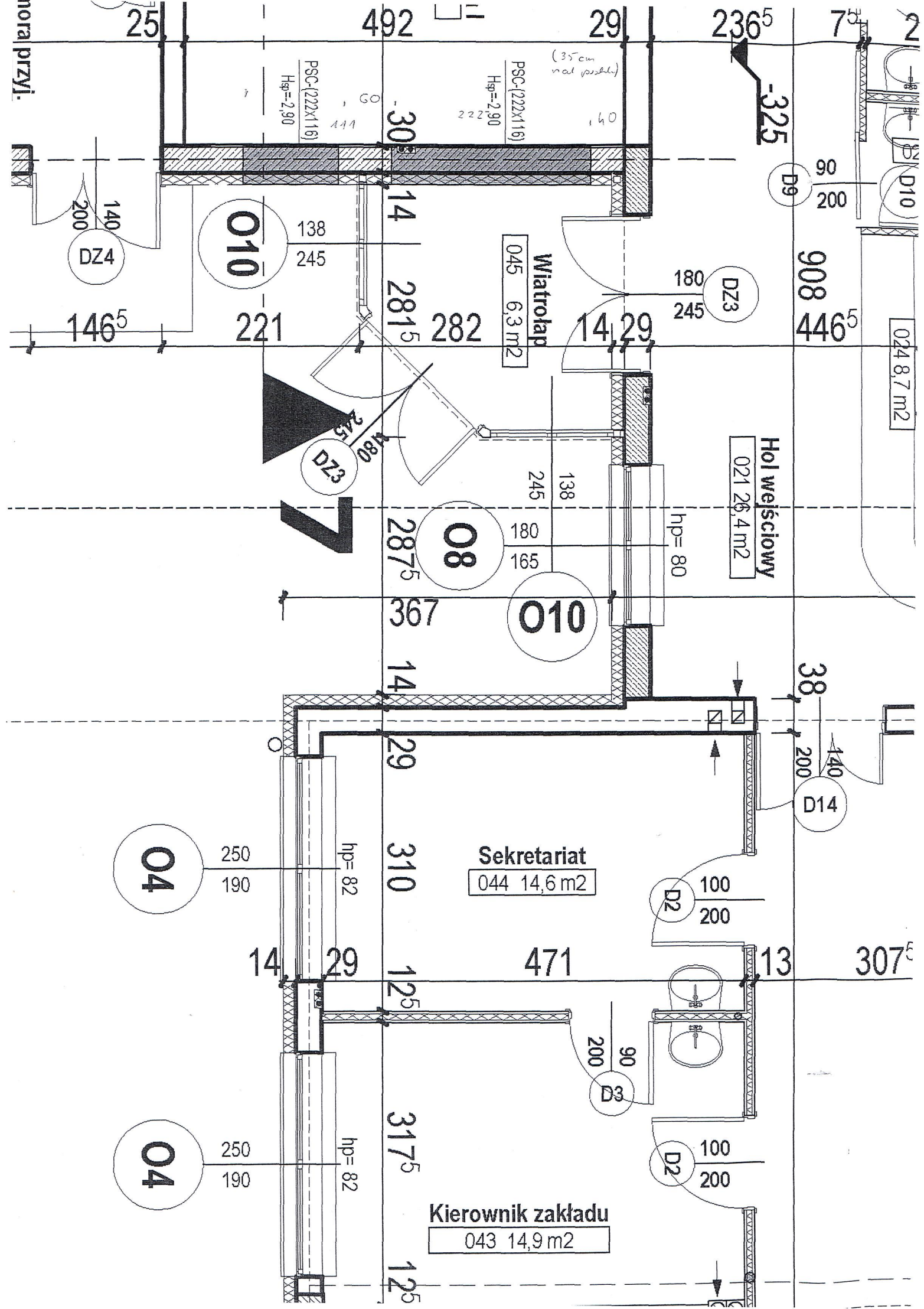

poraj przyj.

25

492

29

236⁵

7⁵

2

PSC-(222X116)
H_{sp}=2,90

PSC-(222X116)
H_{sp}=2,90

(35 cm
nał poskle)

-325

D9

90
200

D10

140
200
DZ4

O10

138
245

14

Wiatrołap
045 6,3 m²

180
245
DZ3

908
446⁵

0248,7 m²

146⁵

221

281⁵

282

14,29

Hol wejściowy
021 26,4 m²
hp=80

245
180
DZ3

245
138

287⁵

180

O10

165

367

38

200
140
D14

O4

250
190

hp=82

29

310

Sekretariat
044 14,6 m²

100
200
D2

14

29

471

13

307⁵

200
90
D3

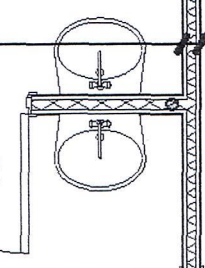

O4

250
190

hp=82

317⁵

12⁵

Kierownik zakładu
043 14,9 m²

100
200
D2

12⁵